

6469872COM GAMING CONSOLE

NTENSE

Date of Purchase ___ / ___ / ___
Lot Number:

B346469872COM01KX

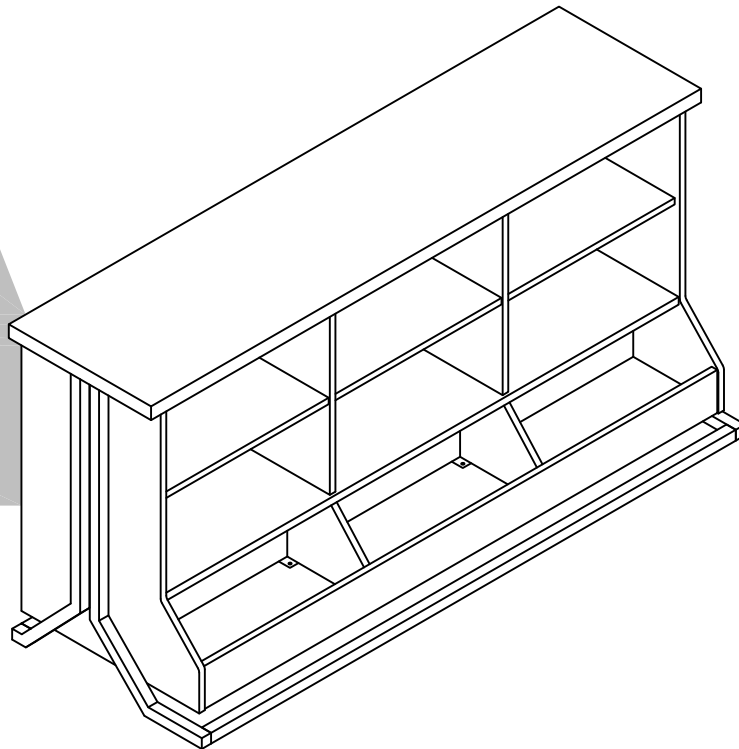

THIS INSTRUCTION BOOKLET CONTAINS **IMPORTANT** SAFETY INFORMATION. PLEASE READ AND KEEP FOR FUTURE REFERENCE.

Do Not Return This Product!

Contact our customer service team for help first.

Call: 1-800-489-3351 (toll free)

Monday-Friday 9am - 5pm CST

Visit: www.ameriwoodhome.com

WARNING

- Unit can tip over causing severe injury or death.
- Anchor unit to stud in wall (if instructed to).
- Do Not allow children to climb on unit.
- Put heavy items on lower shelves or drawers.

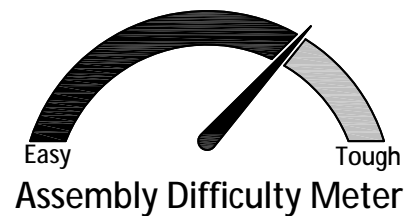

Follow Ameriwood Home



Contact Us!

Do NOT return this product!

Contact our friendly customer service team first for help.

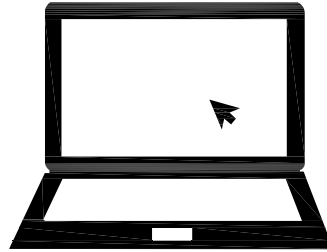

Visit ameriwoodhome.com

Assembly Tips



Helpful Hints

PEOPLE NEEDED FOR ASSEMBLY: 2

ESTIMATED ASSEMBLY TIME: 1.5-2.0 HOURS

- Open your item in the area you plan to keep it to avoid excessive heavy lifting.
- Identify, sort and count the parts before attempting assembly.
- Compression dowels are lightly tapped in with a hammer.
- Slides are labeled with a R (right) and L (left) for proper placement.
- Make sure to always face the point on the top of the Cam Lock towards the outer edge.
- Use all the nails provided for the back panel and spread them out equally.
- Back panel must be used to make sure your unit is sturdy.
- Do NOT use harsh chemicals or abrasive cleaners on this item.
- Never push, pull, or drag your furniture.

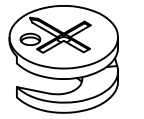

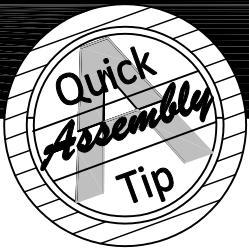

Before You Start

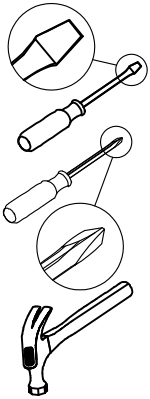

- ✓ Read through each step carefully and follow the proper order
- ✓ Separate and count all your parts and hardware
- ✓ Give yourself enough room for the assembly process
- ✓ Have the following tools: Flat Head Screwdriver, #2 Phillips Head Screwdriver and Hammer
- ✓ Caution: If using a power drill or power screwdriver for screwing, please be aware to slow down and stop when screw is tight. Failure to do so may result in stripping the screw.

Cam Lock Fastening System

This Cam Lock Fastening System will be used throughout the assembly process.

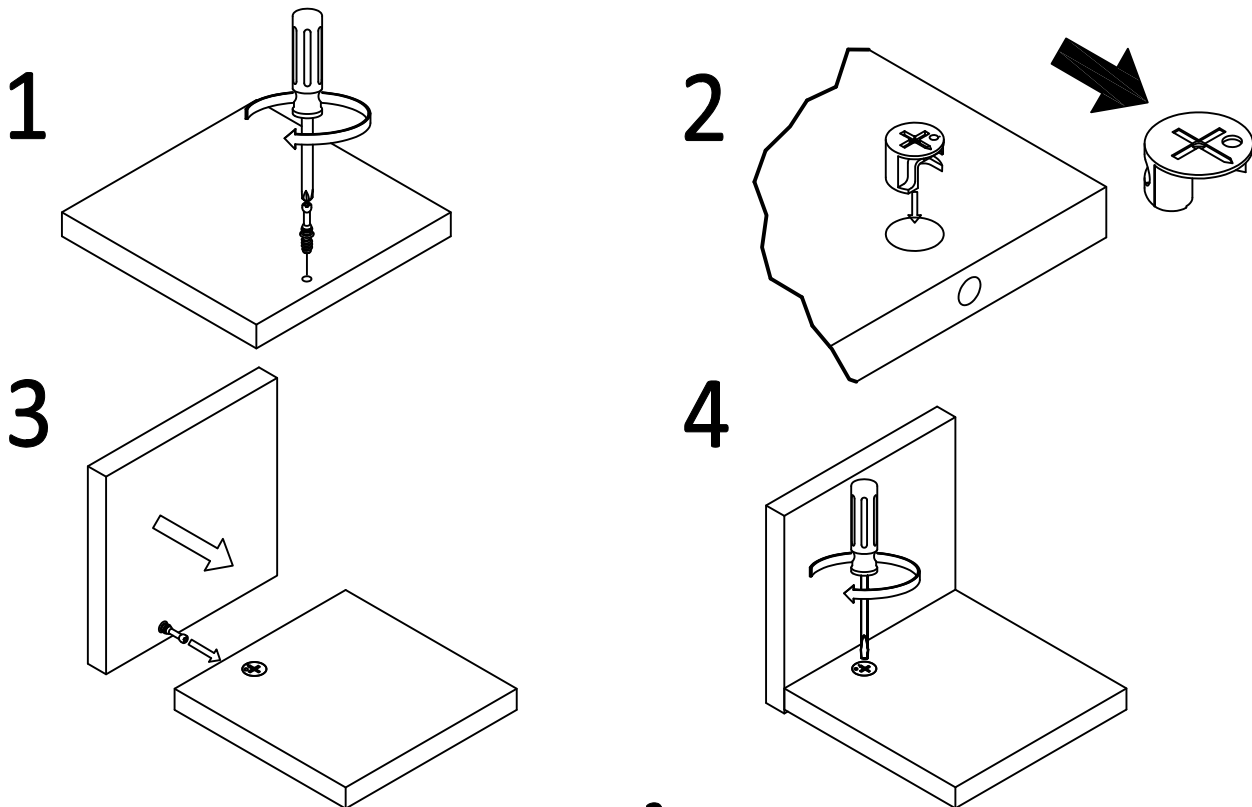

Board Identification

Not Actual Size

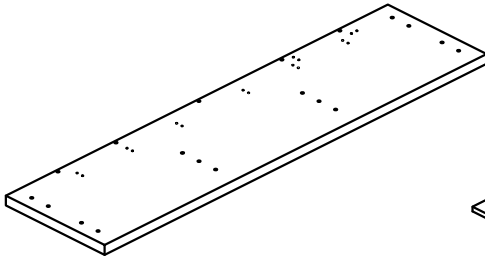

(A)

Top panel
T6469872010KX

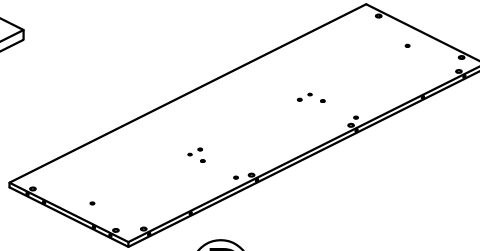

(B)

Bottom panel
T6469872020KX

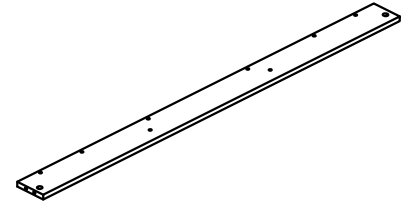

(C)

Front panel
T6469872030KX

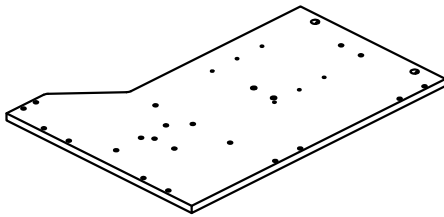

(D)

Left side panel
T6469872040KX

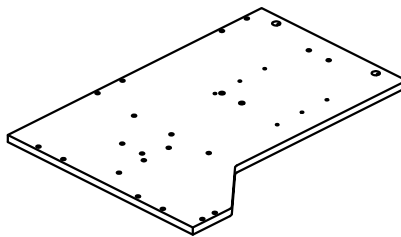

(E)

Right side panel
T6469872050KX

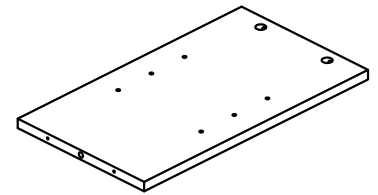

(F)

Upper left partition
T6469872060KX

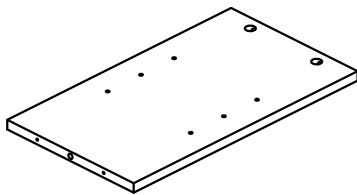

(G)

Upper right partition
T6469872070KX

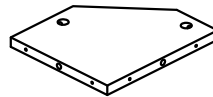

(H)

Lower left partition
T6469872080KX

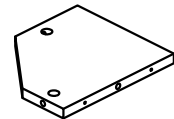

(I)

Lower right partition
T6469872090KX

Board Identification

Not Actual Size

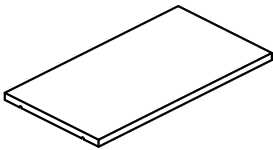

J

Adjustable shelf
T6469872100KX
QTY:2 PCS

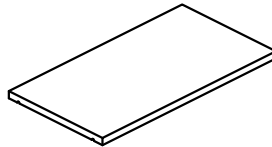

K

Adjustable shelf
T6469872110KX

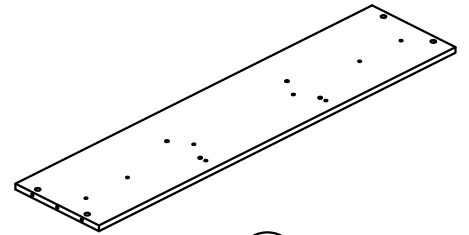

L

Fixed shelf
T6469872120KX

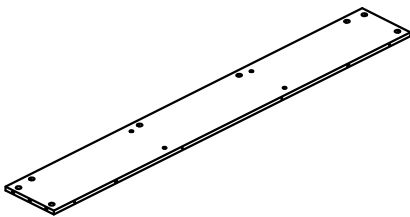

M

Lower back panel
T6469872130KX

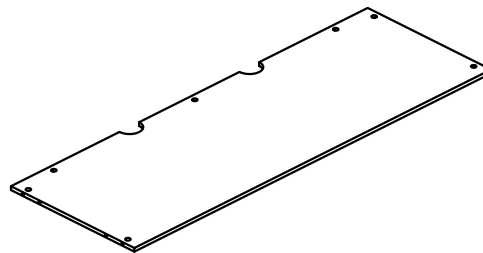

N

Upper back panel
T6469872140KX

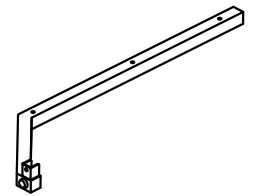

O

Left rear leg
T6469872150KX

Preassembled parts	
Left rear leg	T6469872150KX1
Adjustable foot Ø19	TKX1035

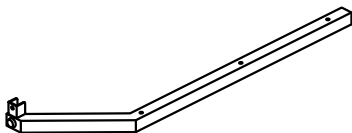

P

Right rear leg
T6469872160KX

Preassembled parts	
Right rear leg	T6469872160KX1
Adjustable foot Ø19	TKX1035

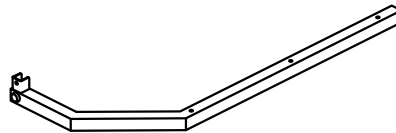

Q

Left front leg
T6469872170KX

Preassembled parts	
Left front leg	T6469872170KX1
Adjustable foot Ø19	TKX1035

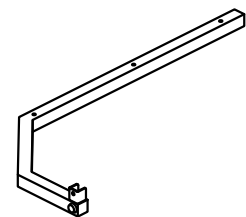

R

Right front leg
T6469872180KX

Preassembled parts	
Right front leg	T6469872180KX1
Adjustable foot Ø19	TKX1035

Board Identification

Not Actual Size

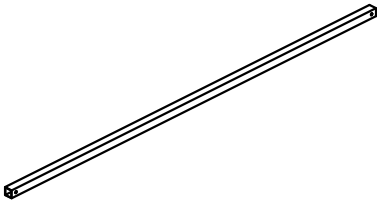

(S)

Support tube
T6469872190KX
QTY:2 PCS



(T)

Leg
T6469872200KX
QTY:2 PCS

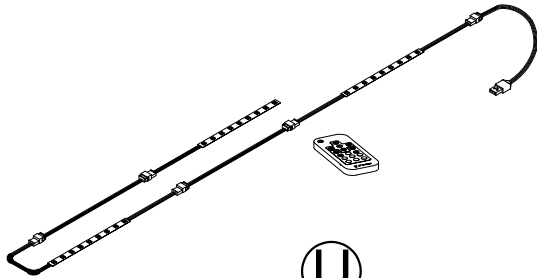

(U)

Led light
T6469872210KX

Preassembled parts	
Leg(2)	T6469872200KX1
Adjustable foot(2) Ø19	TKX1035

Preassembled Parts	
LED light	T6469872210KX1
Remote	T6469872210KX2

Board Identification

Not actual size

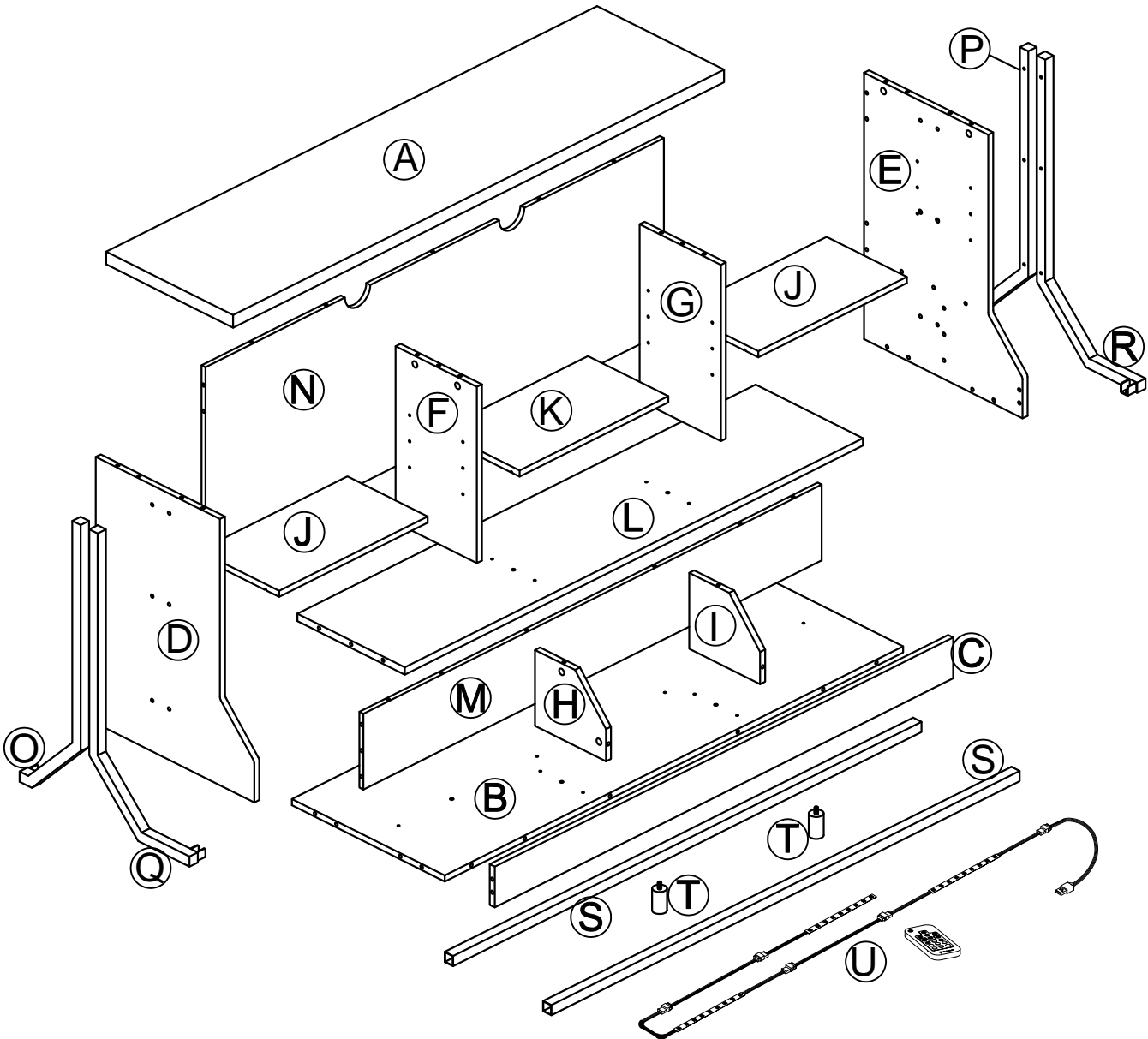

Part List

Actual Size

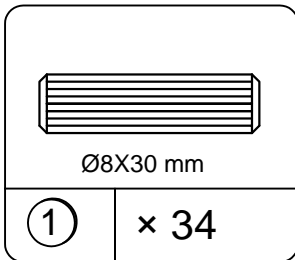

Wood dowel
TKX1005

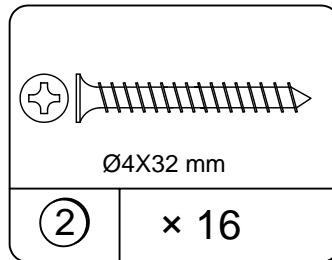

Screw
TKX1455

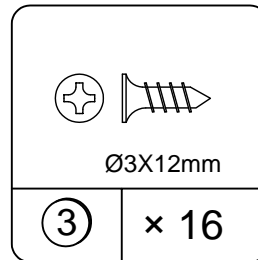

Screw
TKX1146

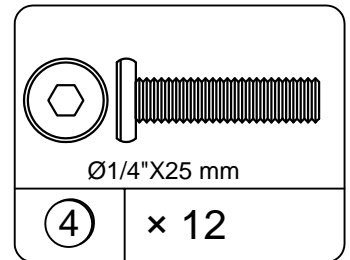

Bolt
TKX1091

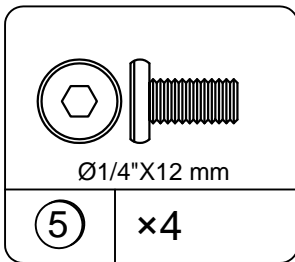

Bolt
TKX1033

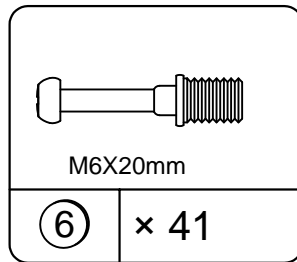

Cam bolt
TKX1270

Part List

Not Actual Size

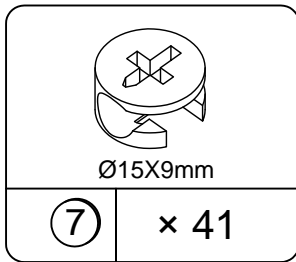

Cam lock
TKX1023

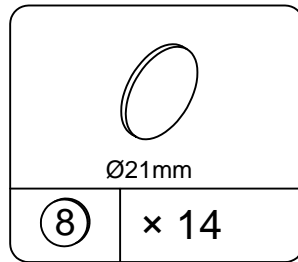

Cam cover
TKX1065

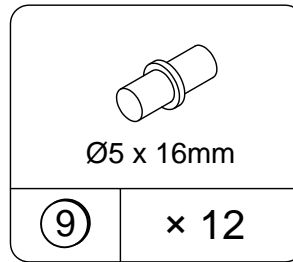

Shelf support
TKX1174

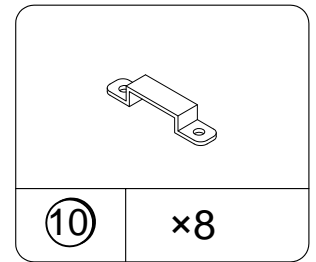

Wire clip
TKX1111

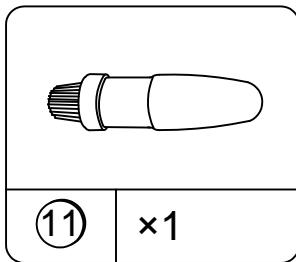

Glue
TKX1014

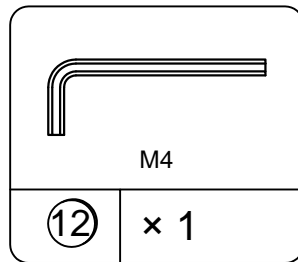

Hex key
TKX1004

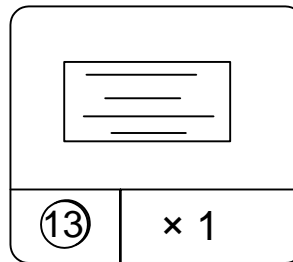

Warning label
TKX3008

STEP 1

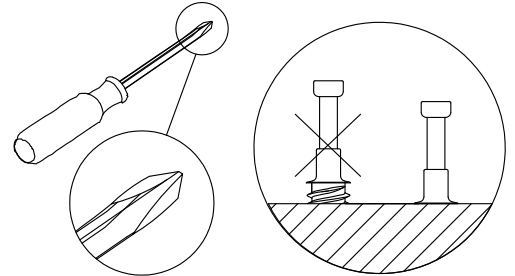
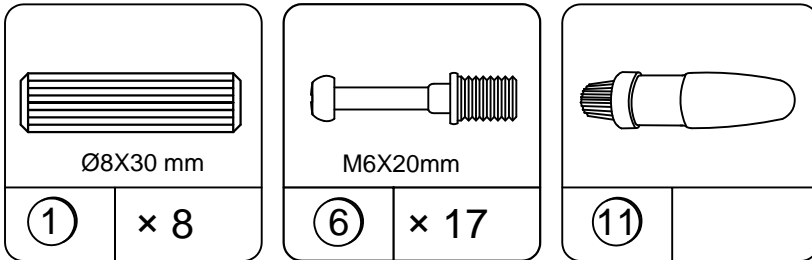

- 1.1 Attach (6) to (A) & (C) as illustrated.
- 1.2 Attach (1) to (B) & (C) as illustrated.

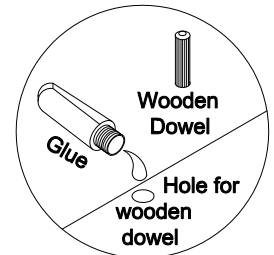

Use one drop of glue in dowel hole.

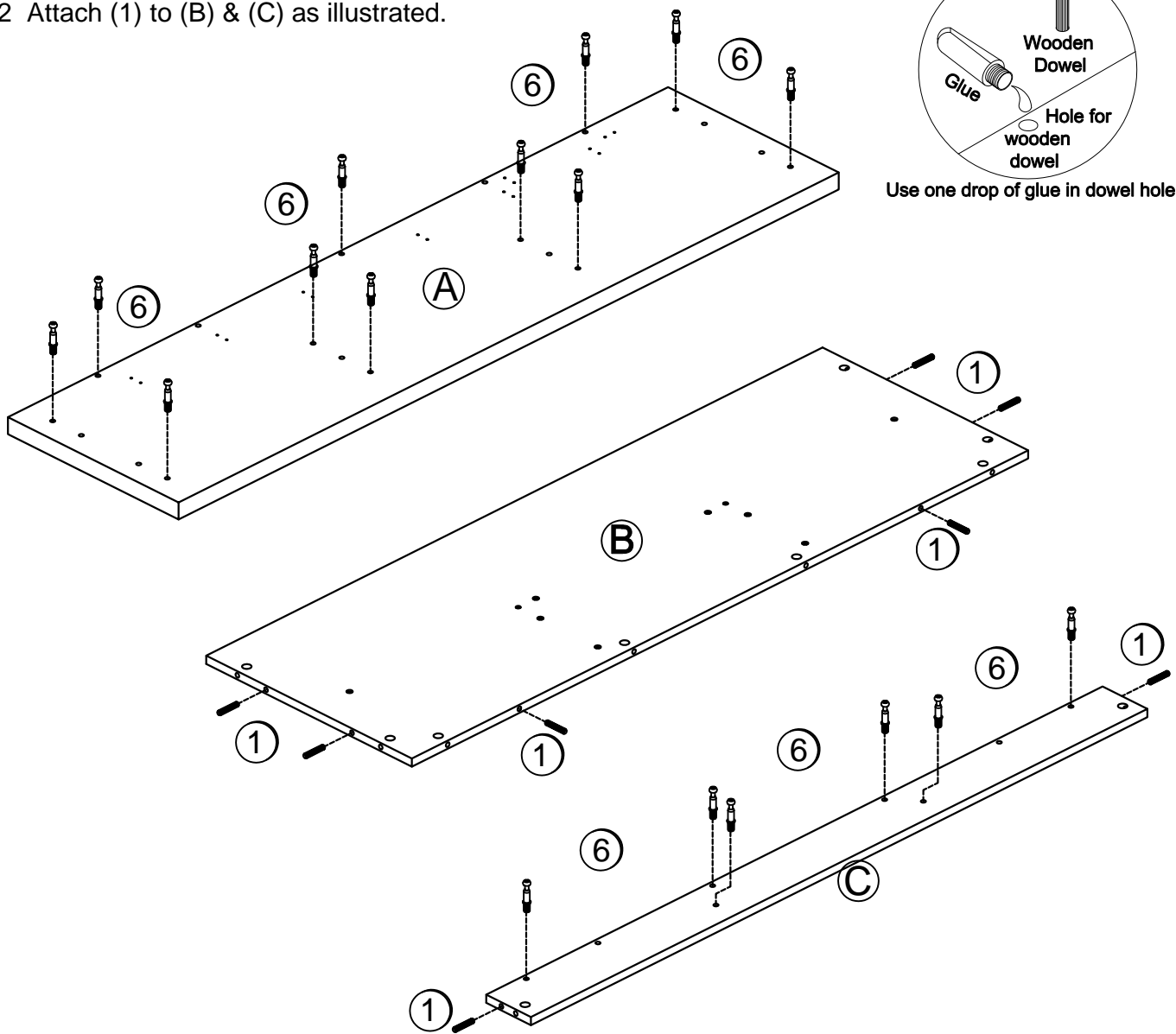

STEP 2

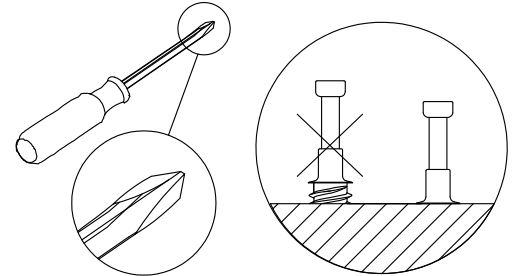
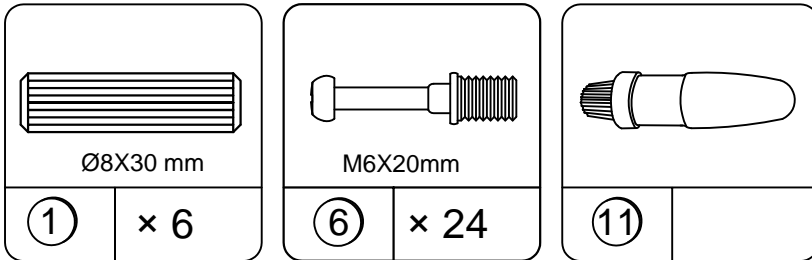

- 2.1 Attach (6) to (D),(E) & (L) as illustrated.
- 2.2 Attach (1) to (D),(E) & (L) as illustrated.

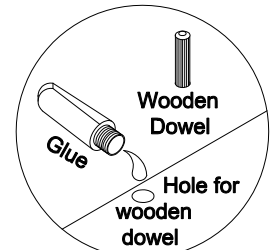

Use one drop of glue in dowel hole.

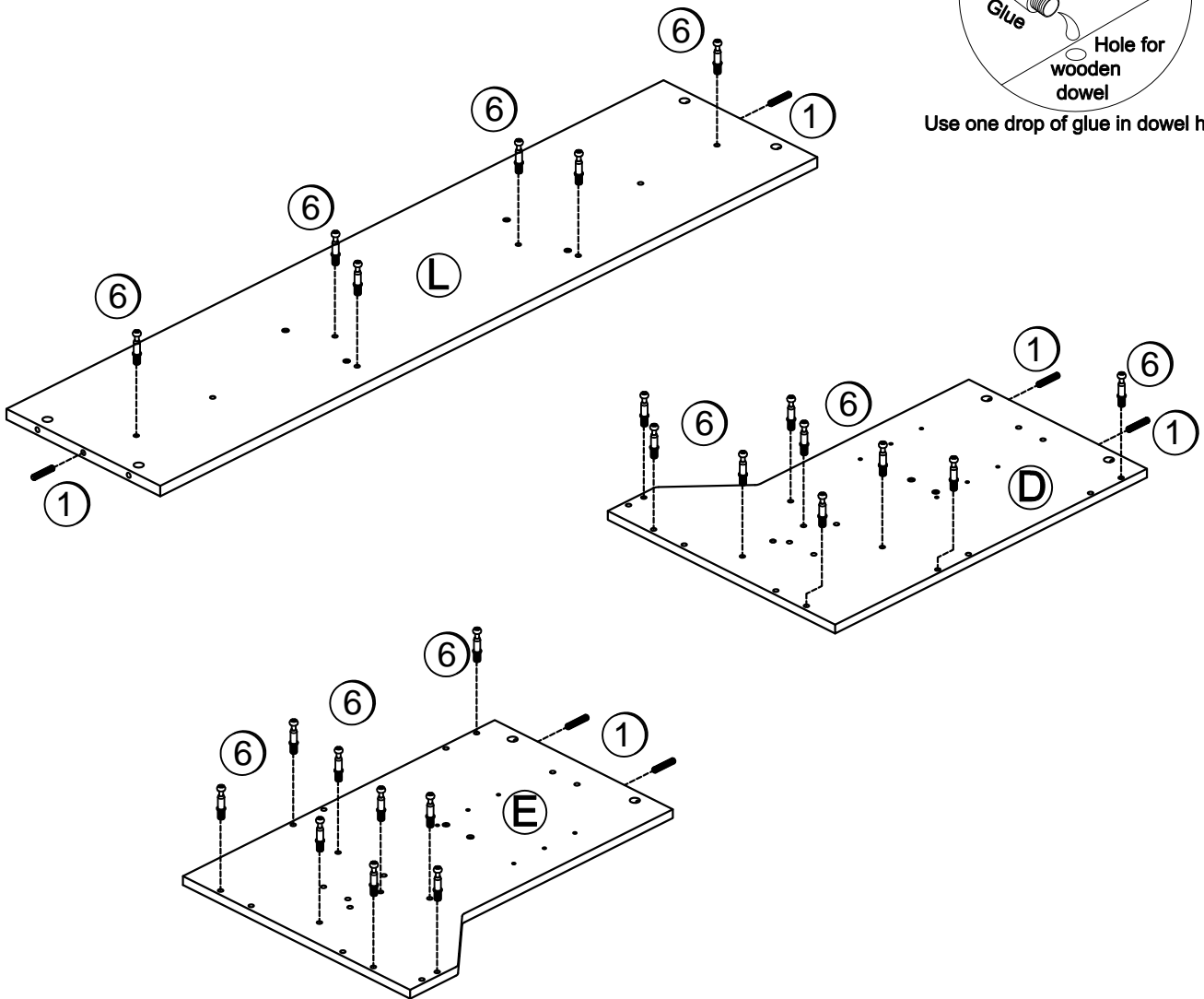

STEP 3

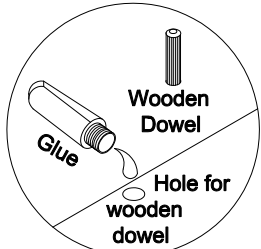
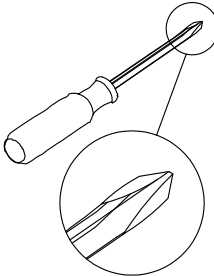
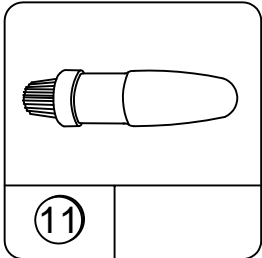
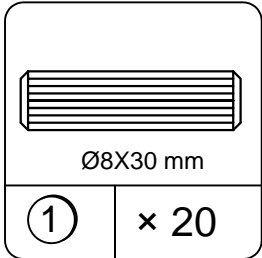

Use one drop of glue in dowel hole.

3.1 Attach (1) to (F),(G),(H),(I),(N) & (M) as illustrated.

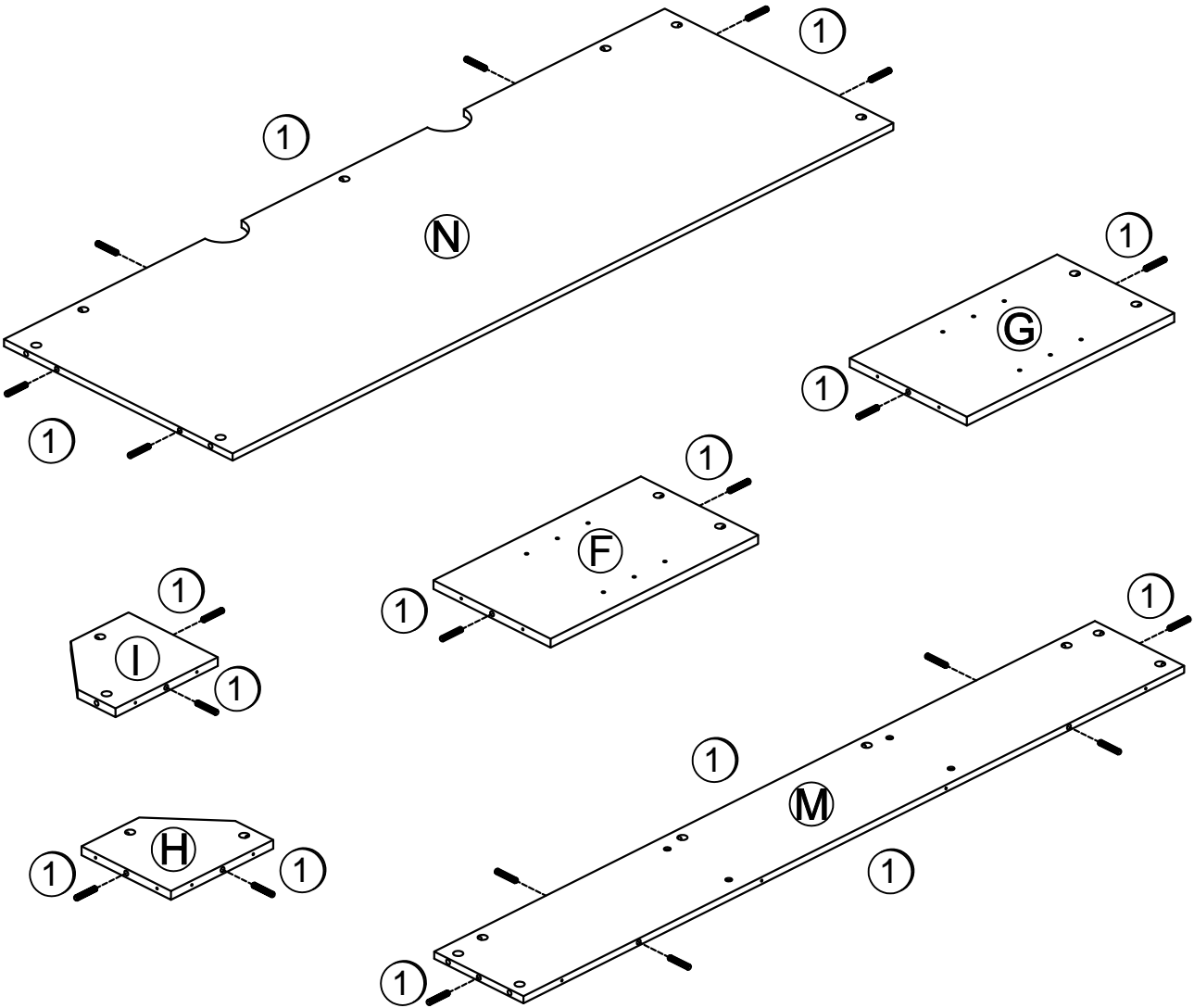

STEP 4

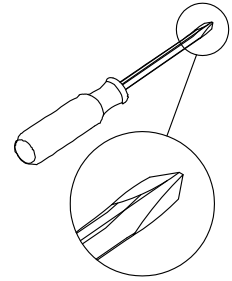
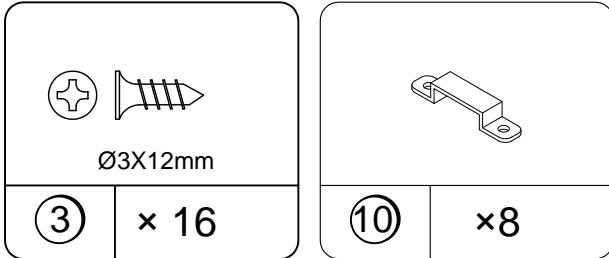

4.1 Attach (U) to (A) with (10) and (3) as illustrated.

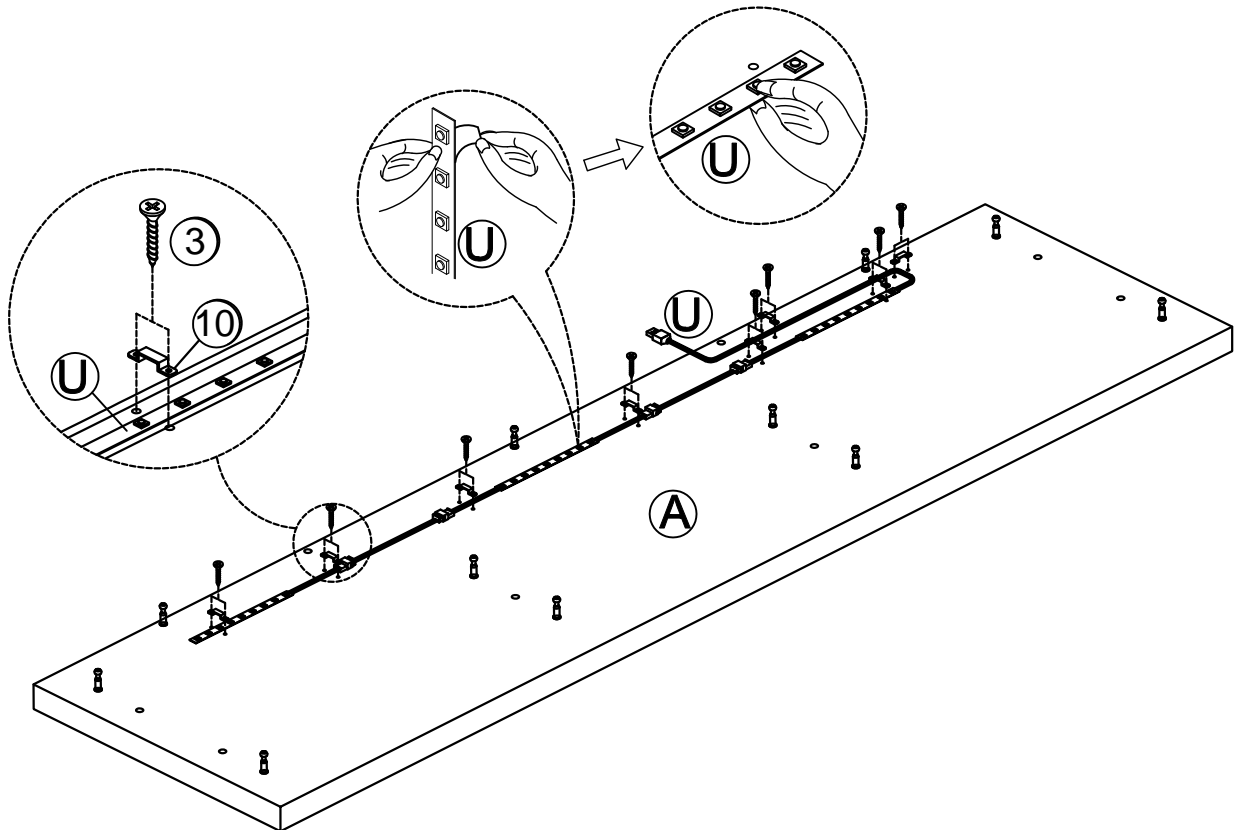

STEP 5

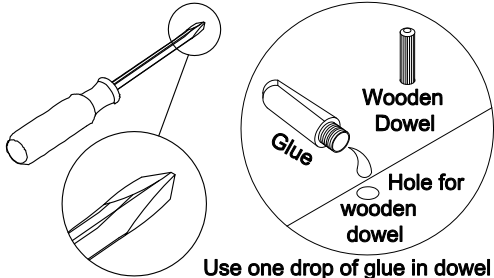
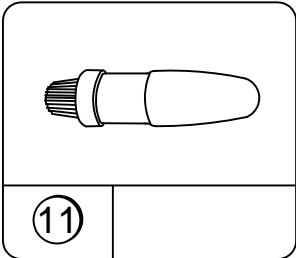
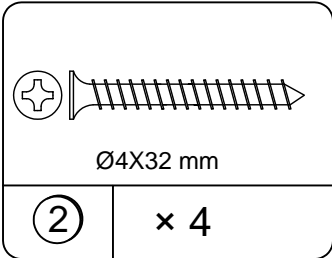

Use one drop of glue in dowel hole.

5.1 Attach (H),(I) to (M) with (2) as illustrated.

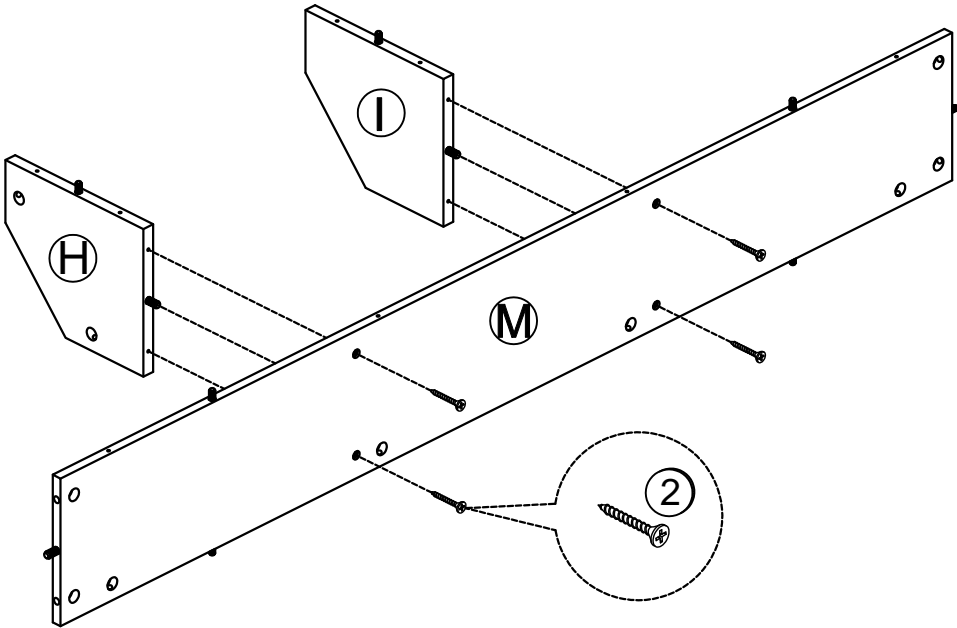

STEP 6

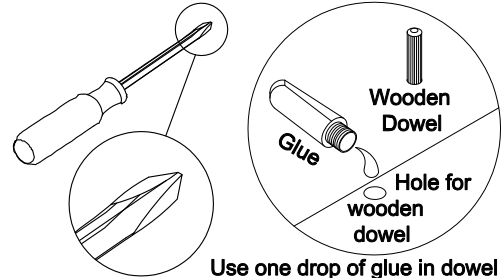
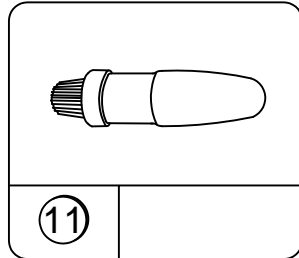
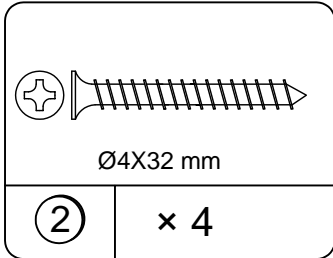

6.1 Attach (F),(G) to (L) with (2) as illustrated.

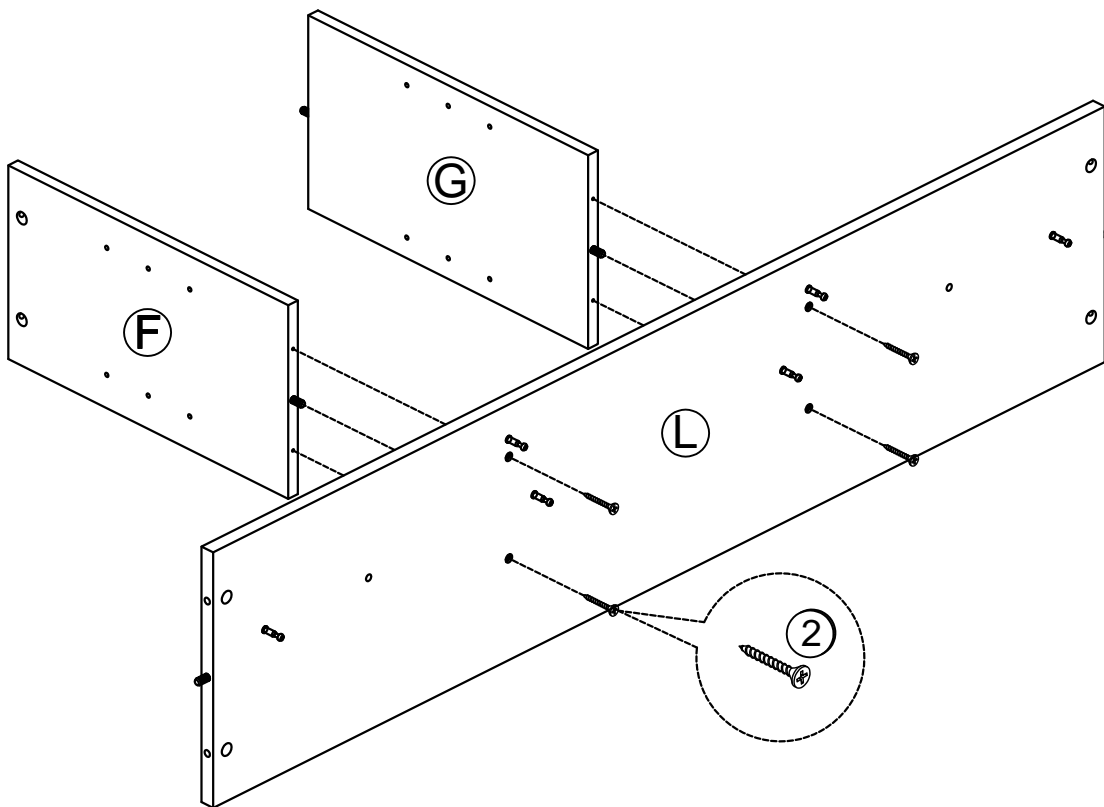

STEP 7

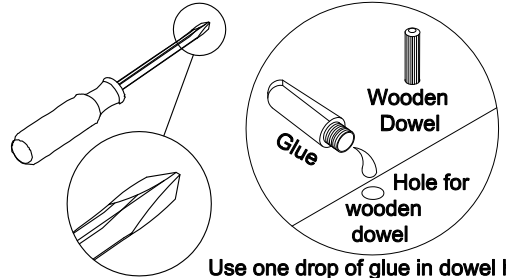
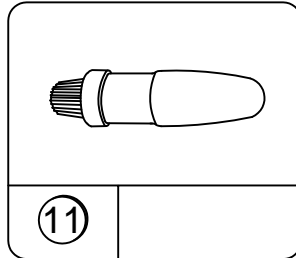
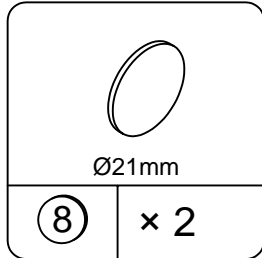
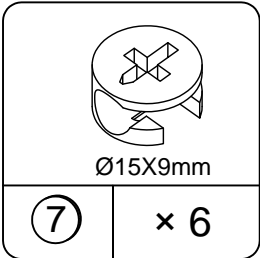

- 7.1 Attach (H), (I), (M) to (L) with (7) as illustrated.
- 7.2 Use (8) to cover cam lock holes as illustrated.

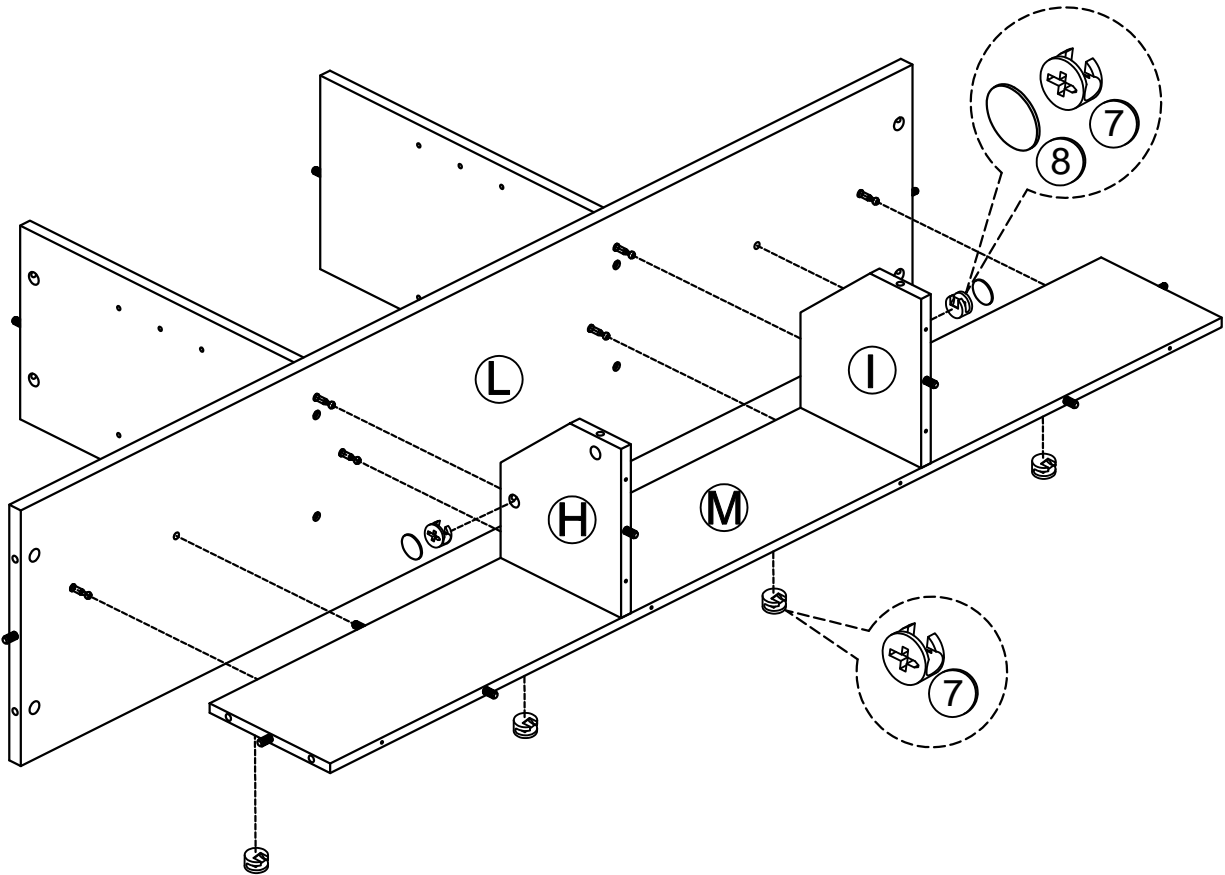
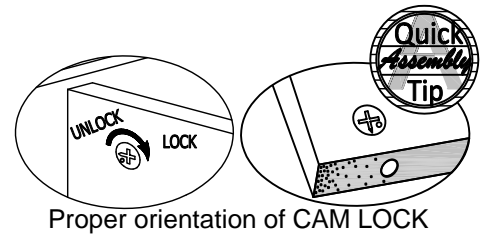

STEP 8

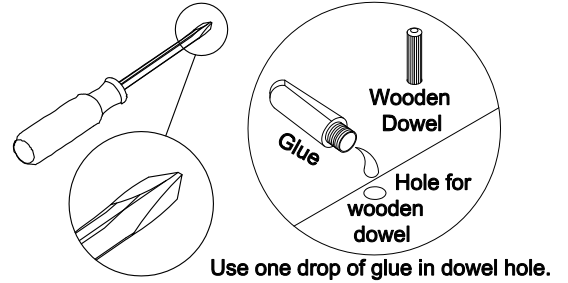
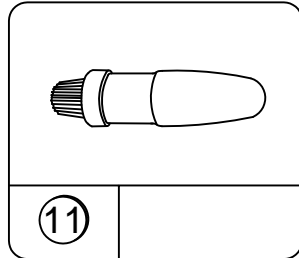
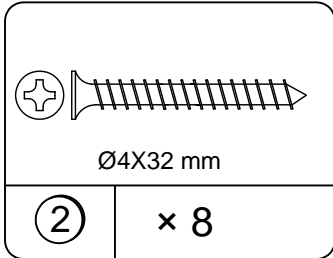

8.1 Attach (B) to sample from previous step with (2) as illustrated.

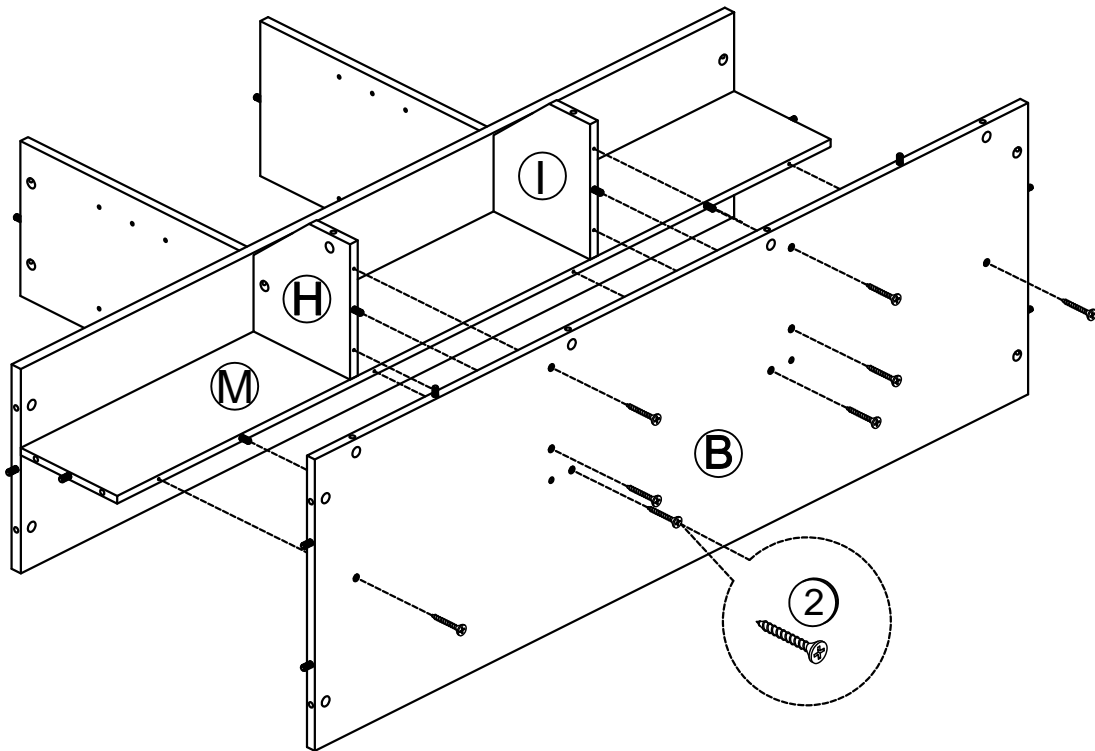

STEP 9

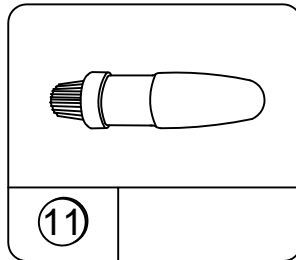
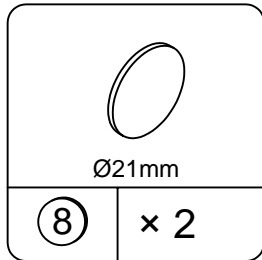
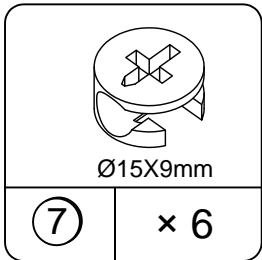

Use one drop of glue in dowel hole.

9.1 Attach (C) to (B),(H) & (I) with (7) as illustrated.

9.2 Use (8) to cover cam lock holes as illustrated.

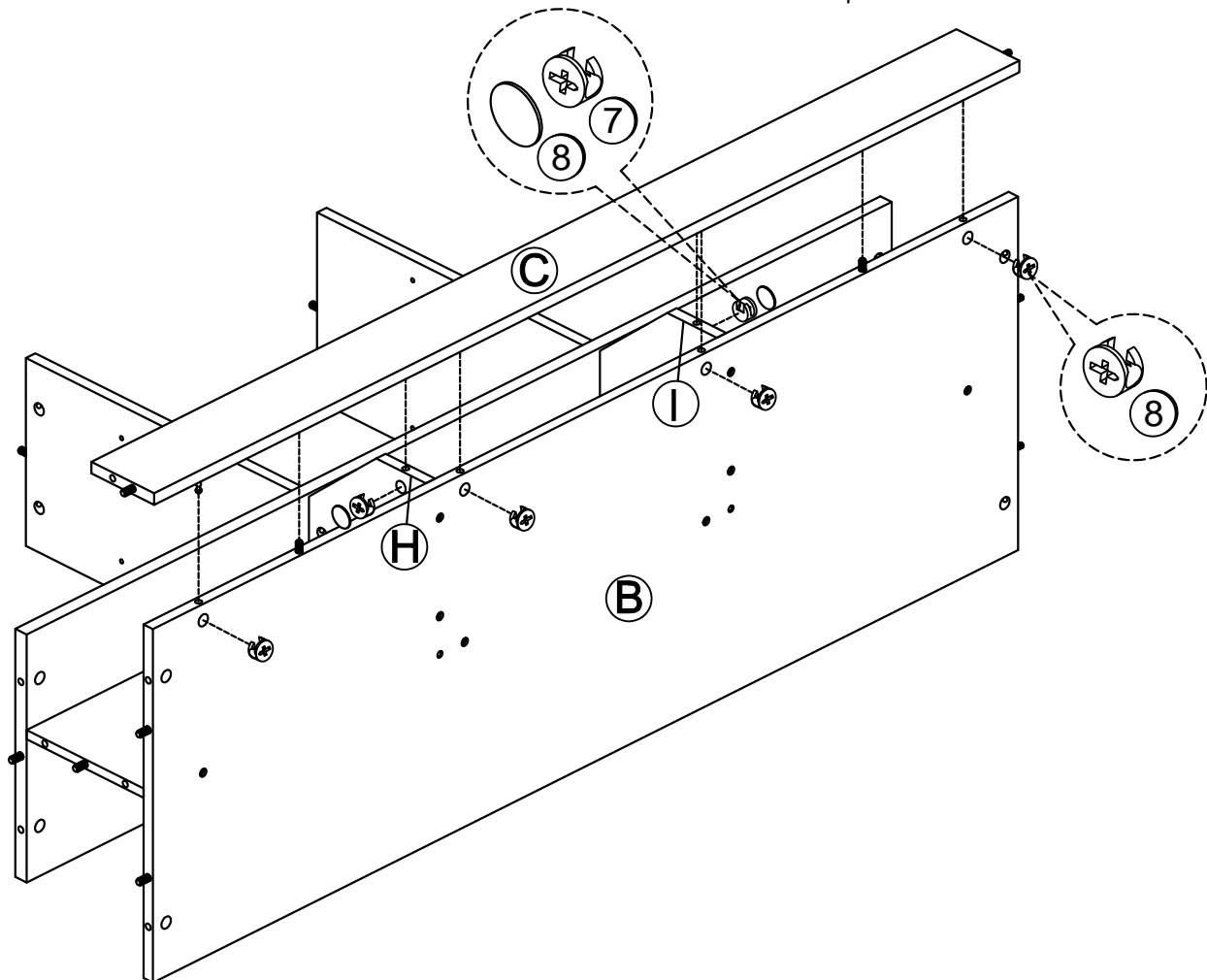
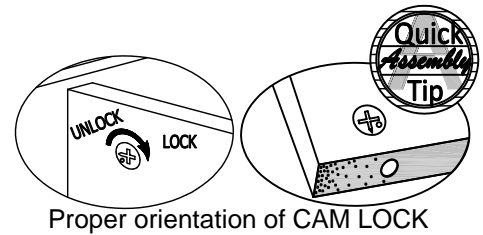

STEP 10

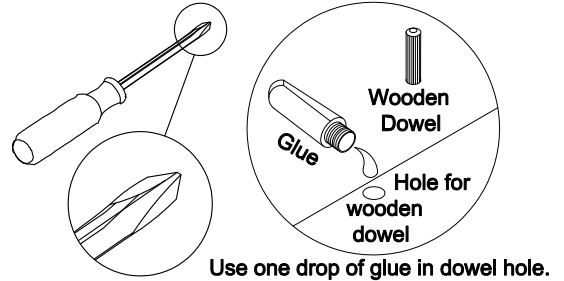
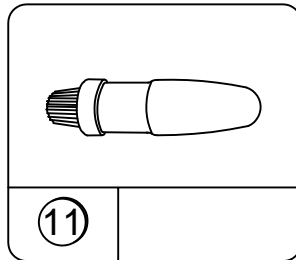
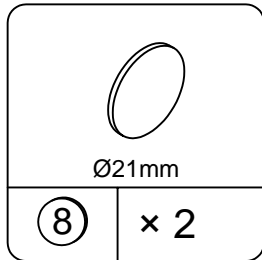
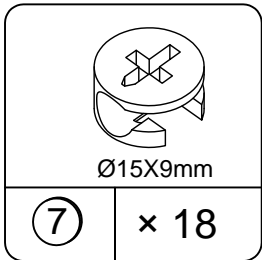

10.1 Attach (D),(E) to sample from previous step with (7) as illustrated.

10.2 Attach (N) to (D) & (E) with (7) as illustrated.

10.3 Use (8) to cover cam lock holes as illustrated.

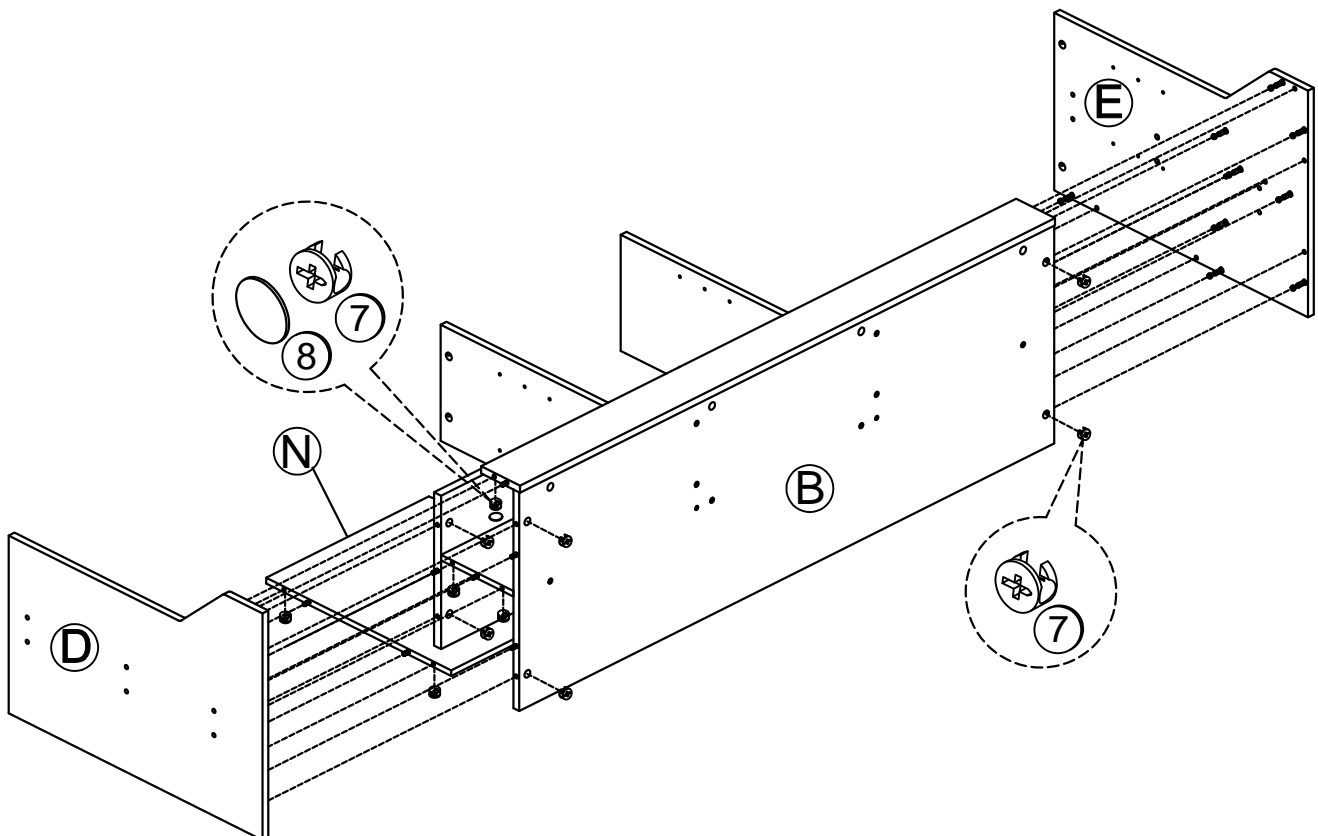
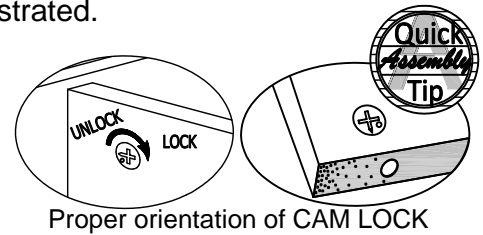

STEP 11

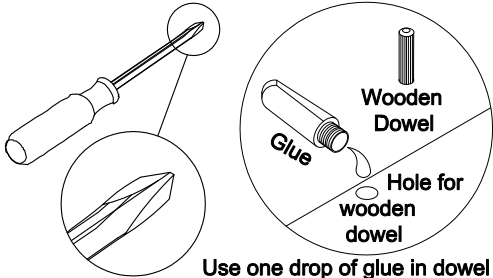
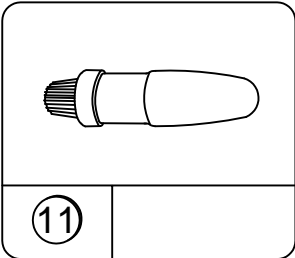
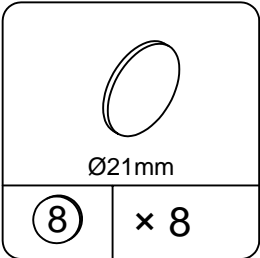
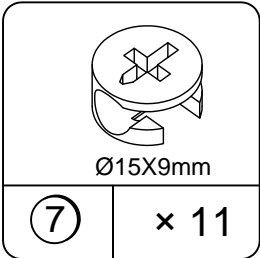

11.1 Attach (A) to sample from previous step with (7) as illustrated.
11.2 Use (8) to cover cam lock holes as illustrated.

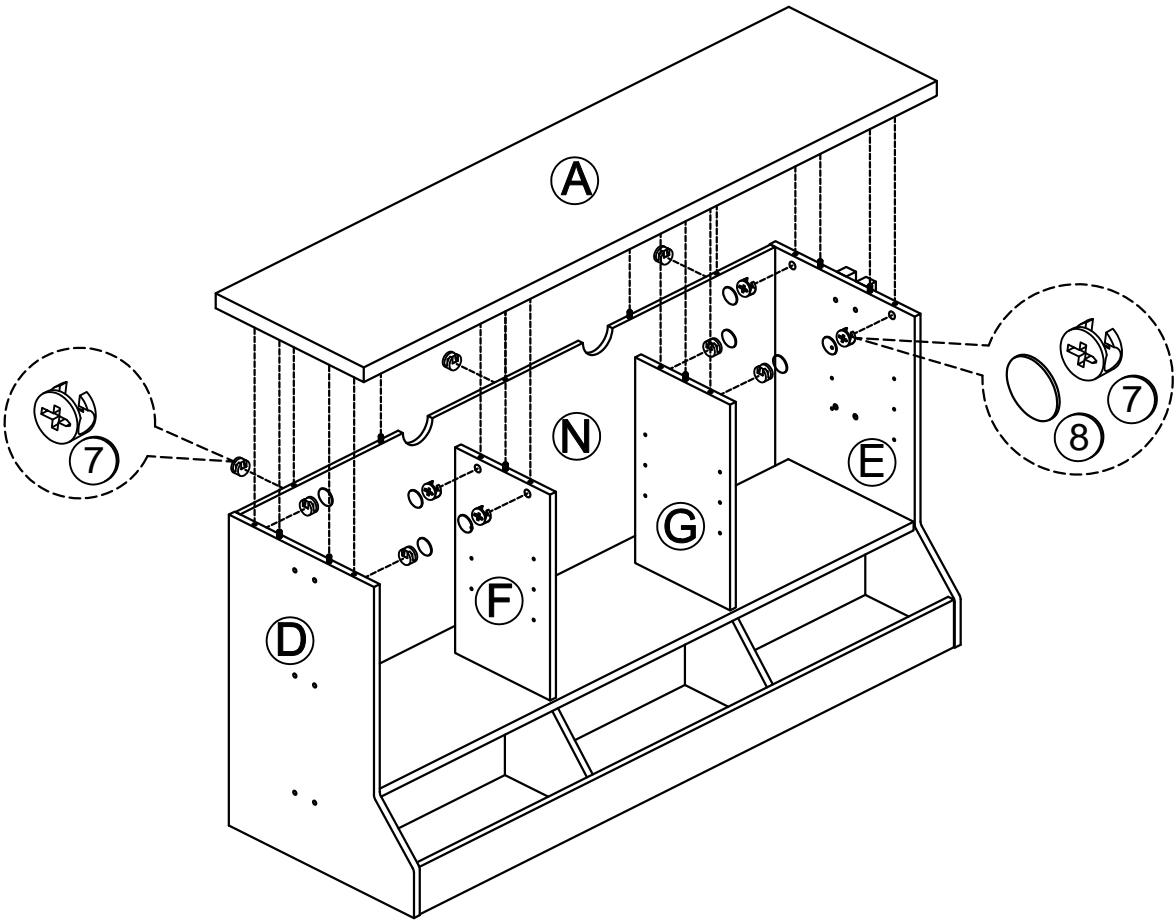
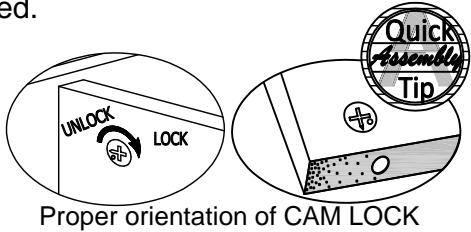

STEP 12

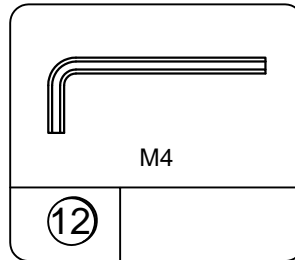
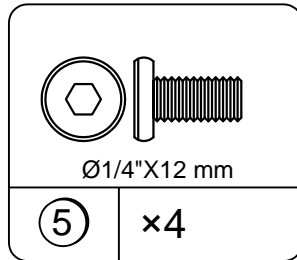
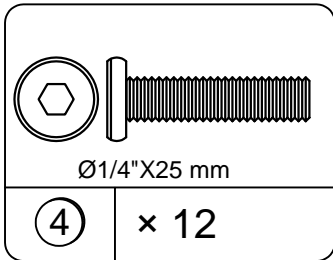

12.1 Attach (O),(P),(Q) & (R) to (D) & (E) with (4) as illustrated.

12.2 Attach (S) to (O),(P),(Q) & (R) with (5) as illustrated.

12.3 Attach (T) to (B) as illustrated.

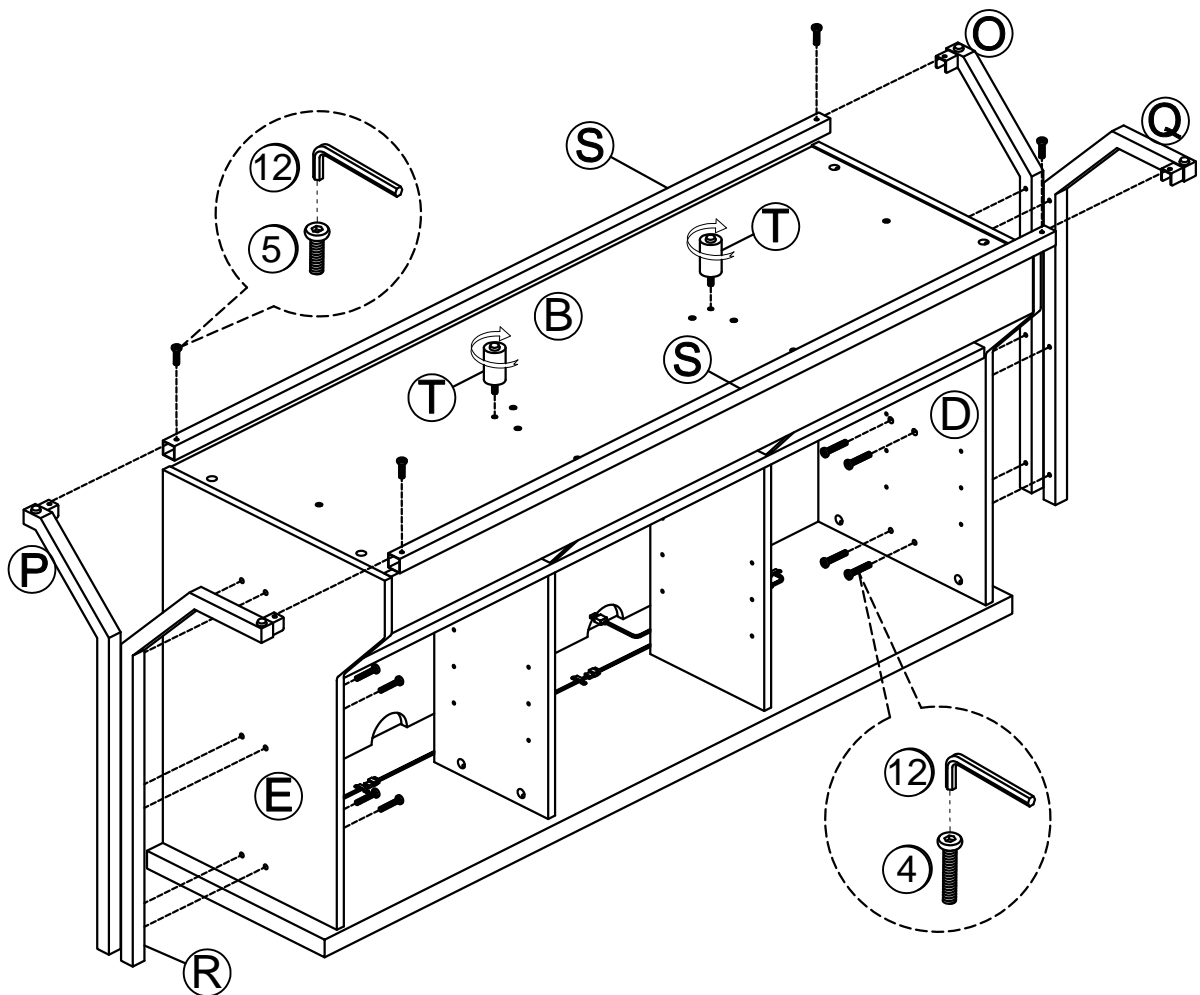

STEP 13

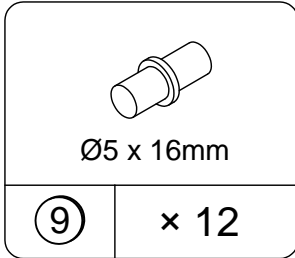

13.1 Insert (9) to (D), (E),(F) & (G) as illustrated.

13.2 Insert and put (J),(K) on (9) as illustrated.

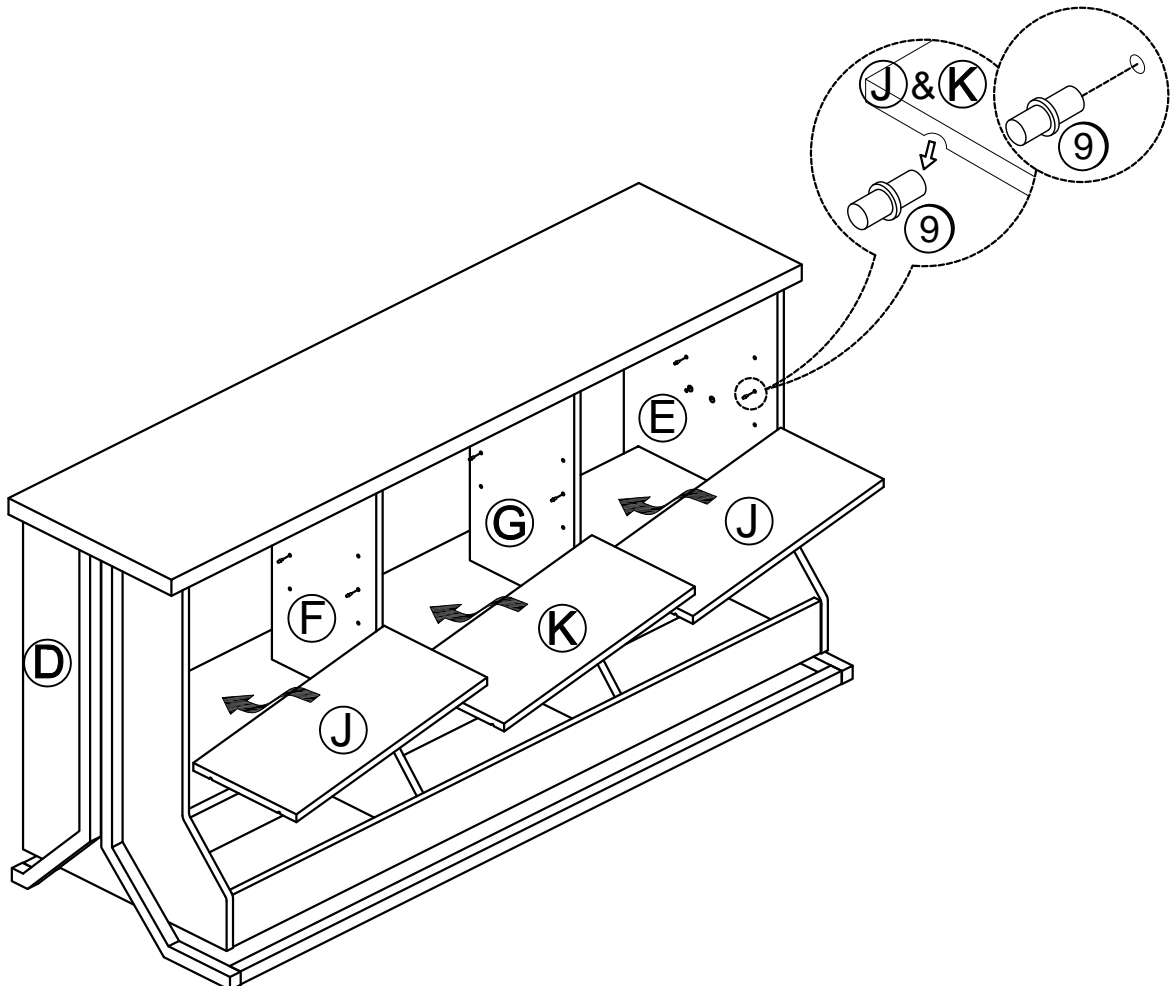

STEP 14

Apply the warning label to the center of the top panel as shown, ensure the TV covers the label in use. You will not be able to remove the label after it is applied to the top panel.

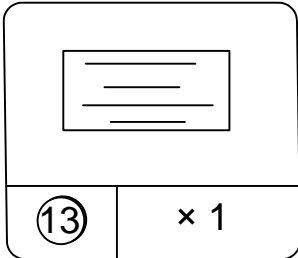

WARNING

Risk of death or serious injury. This unit must be placed against a fixed in place wall at least as tall as television.

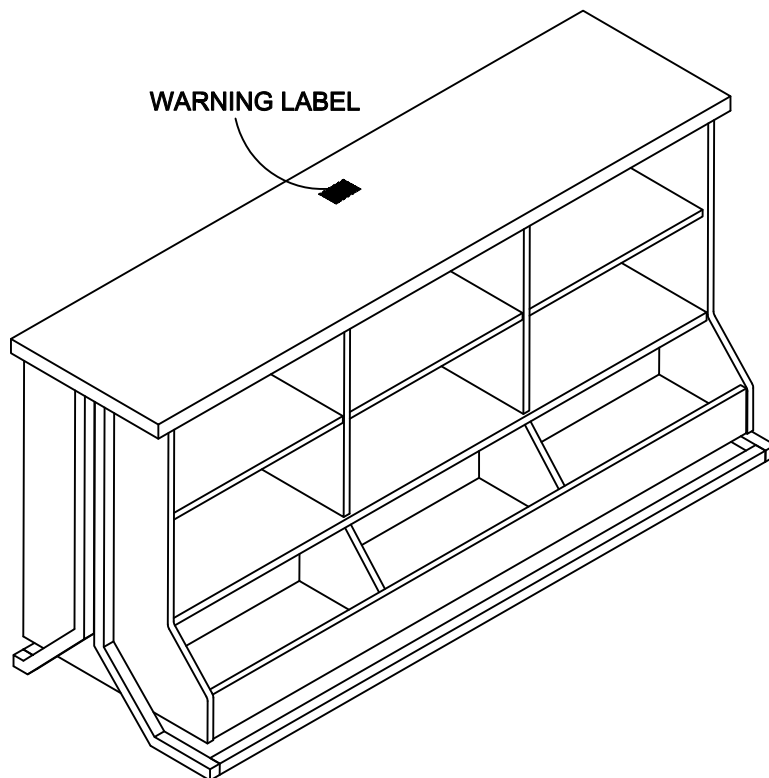

Maximum Loads

This unit has been designed to support the maximum loads shown. Exceeding these load limits could cause sagging, instability, product collapse, and/or serious injury.

Warning: Please apply the TV warning label to your unit so you'll always have the model's weight and TV size limits.

Maximum TV size: 65" flat screen, 120 Lbs/54.5 kgs.

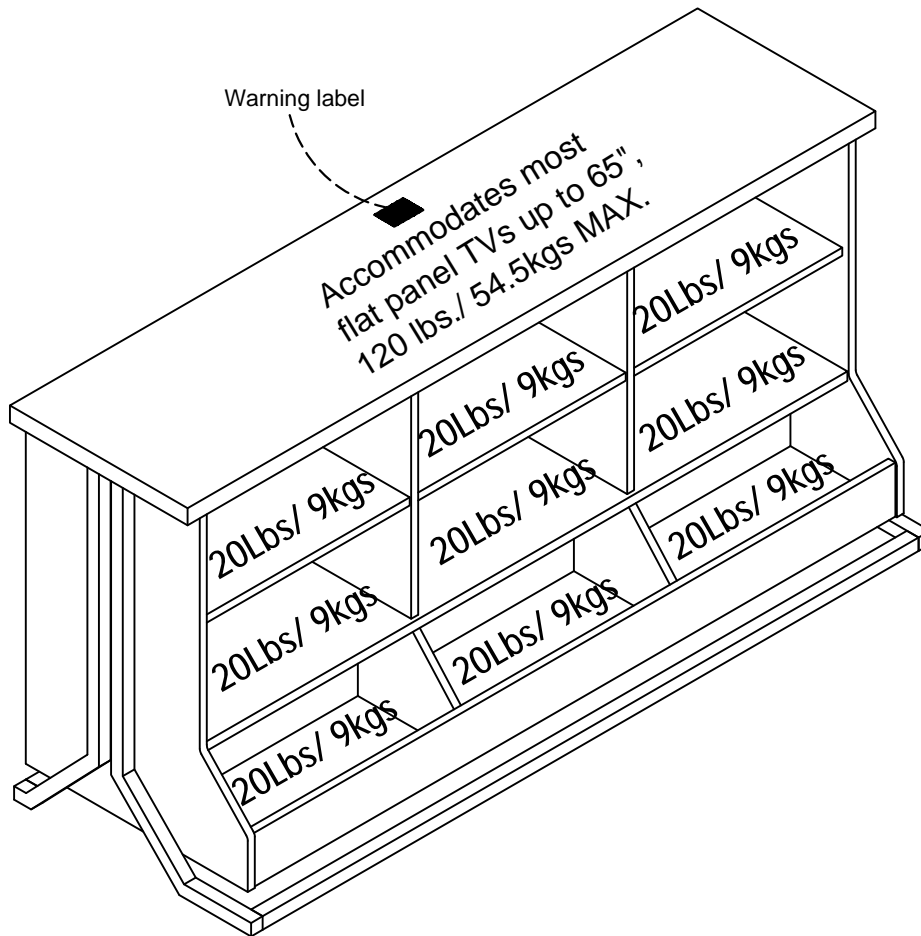

Certificate of Conformity

1. This certificate applies to the Dorel Home Furnishings, Inc. product identified by this instruction manual.
2. This certificate applies to compliance of this product with the CPSC Ban on Lead-Containing Paint (16 CFR 1303).
3. This product is distributed by: Dorel Home Furnishings, Inc.
410 East First Street South
Wright City, MO 63390
636-745-3351
4. Site of Manufacture: Svay Rieng, Cambodia
5. See front page of instruction manual for date of manufacture.

Register your product to receive the following:



- * New trend details - sneak peek on what's new
- * Surveys - have a voice within our community
- * Exclusive deals and discount codes
- * Quick and easy replacement part service

To register your product, visit ameriwoodhome.com

Star Rating



Visit your local retailer's website, rate your purchased product and leave us some feedback!

We would like to extend a big "Thank You" to all of our customers for taking the time to assemble this Ameriwood Home product, and to give us your valuable feedback.

Thank You!

Cubierta Delantera

Este libro de instrucciones contiene información **IMPORTANTE** de seguridad. Por favor lea y manténgalo para referencia en el futuro.

No Regrese este producto! Comuníquese con nuestro amistoso equipo de servicio al cliente para obtener ayuda.

Llámenos al: 1-800-489-3351 (Gratis) Lunes - Viernes 9am - 5pm CST

Visitar: www.ameriwoodhome.com

PRECAUCION

Este mueble puede volcarse y causar graves heridas y/o muerte.

Anclar el mueble a un poste de madera en la pared (si esto se requiere).

No Permita que los niños monten el mueble.

Mantenga los artículos más pesados en los cajones de abajo.

Consejos Útiles (página 2)

- Abra su artículo en el área donde usted planea utilizarlo para evitar levantar y moverlo menos
- Identificar, ordenar y contar las piezas antes de intentar ensamblar
- Las clavijas de compresión se golpean con un martillo
- Las diapositivas están marcadas con una R (derecha) y L (izquierda) para la colocación correcta
- Asegúrese de que siempre este el punto localizado en la parte superior de bloqueador de leva este volteado hacia borde exterior
- Utilizar todos los clavos para el panel de atrás y distribuirlos por igual
- El panel de atrás debe utilizarse para asegurarse de que la unidad quede fija y firme
- No use químicas fuertes ni limpiadores abrasivos en este artículo
- Nunca empuje, tire ni arrastre los muebles

Antes de Que Empieces (página 3)

- Lea cuidadosamente cada paso y siga el orden correcto

- Separe y contar todas sus piezas y hardware

- Dése suficiente espacio para el proceso de ensamble

- Tenga las siguientes herramientas: destornillador de cabeza plana, #2 cabeza Phillips

Destornillador y martillo

- Precaución: Si usa un taladro electrónico o un destornillador eléctrico para atornillar, por favor asegúrese que deje de atornillar cuando el tornillos este apretado. Fallar hacer esto puede causar barrer el tornillo.

Sistema de fijar el bloqueo de leva (página 3)

Esta sistema de fijar el bloqueo de leva sera usado en todo el proceso ensamble.

Español

Identificación de los Paneles (Página 4-7)

Este no es el tamaño real

- (A) PANEL SUPERIOR
- (B) PANEL INFERIOR
- (C) PANEL FRONTAL
- (D) PANEL LATERAL IZQUIERDO
- (E) PANEL LATERAL DERECHO
- (F) PARTICIÓN SUPERIOR IZQUIERDA
- (G) TABIQUE SUPERIOR DERECHO
- (H) PARTICIÓN INFERIOR IZQUIERDA
- (I) PARTICIÓN INFERIOR DERECHA
- (J) ESTANTE AJUSTABLE
- (K) ESTANTE AJUSTABLE

- (L) ESTANTE FIJO
- (M) PANEL TRASERO INFERIOR
- (N) PANEL SUPERIOR TRASERO
- (O) PATA TRASERA IZQUIERDA
- (P) PATA TRASERA DERECHA
- (Q) PATA DELANTERA IZQUIERDA
- (R) PATA DELANTERA DERECHA
- (S) TUBO DE SOPORTE
- (T) PIERNA
- (U) LUZ LED

Lista de Piezas (Página 8)

Tamaño real

- (1) Taco de madera
- (2) Tornillo
- (3) Tornillo
- (4) Perno
- (5) Perno
- (6) Perno de leva

Lista de Piezas (Página 9)

Este no es el tamaño real

- (7) Bloqueo de leva
- (8) Cubierta de leva
- (9) Soporte de estante
- (10) Clip de alambre
- (11) Pegamento
- (12) Llave hexagonal
- (13) Etiqueta de advertencia

Página 10

1.1 Fije (6) a (A) y (C) como se ilustra.

1.2 Fije (1) a (B) y (C) como se ilustra.

Página 11

2.1 Fije (6) a (D), (E) y (L) como se ilustra.

2.2 Fije (1) a (D), (E) y (L) como se ilustra.

Página 12

3.1 Fije (1) a (F), (G), (H), (I), (N) y (M) como se ilustra.

Página 13

4.1 Fije (U) a (A) con (10) y (3) como se ilustra.

Página 14

5.1 Fije (H), (I) a (M) con (2) como se ilustra.

Página 15

6.1 Fije (F), (G) a (L) con (2) como se ilustra.

Página 16

7.1 Fije (H), (I), (M) a (L) con (7) como se ilustra.

7.2 Use (8) para cubrir los orificios de bloqueo de leva como se ilustra.

Página 17

8.1 Adjunte (B) a la muestra del paso anterior con (2) como se ilustra.

Página 18

9.1 Fije (C) a (B), (H) y (I) con (7) como se ilustra.

9.2 Use (8) para cubrir los orificios de bloqueo de leva como se ilustra.

Página 19

10.1 Adjunte (D), (E) a la muestra del paso anterior con (7) como se ilustra.

10.2 Fije (N) a (D) y (E) con (7) como se ilustra.

10.3 Use (8) para cubrir los orificios de bloqueo de leva como se ilustra.

Página 20

11.1 Adjunte (A) a la muestra del paso anterior con (7) como se ilustra.

11.2 Use (8) para cubrir los orificios de bloqueo de leva como se ilustra.

Página 21

12.1 Fije (O), (P), (Q) y (R) a (D) y (E) con (4) como se ilustra.

12.2 Fije (S) a (O), (P), (Q) y (R) con (5) como se ilustra.

12.3 Conecte (T) a (B) como se ilustra.

Página 22

13.1 Inserte (9) a (D), (E), (F) y (G) como se ilustra.

13.2 Inserte y coloque (J), (K) en (9) como se ilustra.

Página 23

Aplique la etiqueta de advertencia en el centro del panel superior como se muestra, asegúrese de que el televisor cubra la etiqueta en uso.

No podrá quitar la etiqueta después de aplicarla al panel superior.

Advertencia: Riesgo de muerte o lesiones graves. Esta unidad debe colocarse contra una pared fija al menos tan alta como un televisor.

Página 24

CARGA MAXIMA

Esta unidad ha sido diseñada para soportar la carga máxima anotada. El exceder estos límites puede causar inestabilidad, colapsarse y/o causar serias lesiones.

ADVERTENCIA: aplique la etiqueta de advertencia de TV a su unidad para que siempre tenga los límites de peso y tamaño de TV del modelo.

Tamaño máximo del televisor: pantalla plana de 65".

Página 25

Registre su producto para recibir lo siguiente:

- * Detalles de nuevas tendencias - Vistazo a lo nuevo
- * Encuestas - aloc su voz entre su comunidad
- * Códigos de ofertas y descuentos exclusivos
- * Fácil y rápido servicio de partes de remplazo

Para registrar su producto, visite ameriwoodhome.com - Clasificación de 5 estrellas

Visite el sitio web de su distribuidor local, califique el producto que compró y déjenos sus comentarios.

Nos gustaría enviar un gran "Agradecimiento" a todos nuestros clientes por tomarse el tiempo de ensamblar este producto de Ameriwood Home, y por darnos sus valiosos comentarios.

Gracias

Couverture Avant

CE LIVRET D'INSTRUCTION CONTIENT DES INFORMATIONS **IMPORTANTES** SUR LA SÉCURITÉ. VEUILLEZ LIRE ET GARDER POUR UNE RÉFÉRENCE FUTURE

Ne retournez pas ce produit! Contactez notre équipe de service à la clientèle amicale d'abord pour obtenir de l'aide.

Appelez-nous: 1-800-489-3351 (sans frais) du Lundi au Vendredi de 9h à 17h Heure Centrale

Visitez: www.ameriwoodhome.com

ATTENTION

Le meuble peut basculer et causer des blessures graves ou la mort.

Ancrer le meuble à une planche murale dans le mur (si indiqué).

Ne laissez pas les enfants grimper sur le meuble.

Placez les articles lourds sur les étagères ou dans les tiroirs inférieurs.

Astuces Utiles (page 2)

- Ouvrez votre article dans la zone que vous prévoyez de le garder pour moins de levage lourd
- Identifier, trier et compter les pièces avant d'essayer d'assembler
- Les goujons de compression sont taraudés avec un Marteau
- Les glissières sont marquées d'un R (droit) et d'un L (gauche) pour un bon placement
- Assurez-vous toujours de faire face la pointe situé sur le haut de la Serrure de Came vers le bord extérieur
- Utiliser tous les clous fournis pour le panneau arrière et les répartir également
- Le panneau arrière doit être utilisé pour vous assurer que votre appareil est robuste
- N'utilisez pas de produits chimiques agressifs ou de nettoyeurs abrasifs sur cet appareil
- Ne jamais pousser, tirer, ou faire glisser votre meuble

Avant de Commencer (page 3)

- Lisez attentivement chaque étape et suivez le bon ordre
- Séparez et comptez toutes vos pièces et matériaux
- Donnez-vous suffisamment de place pour l'assemblage
- Avoir les outils suivants: tournevis à tête plate, #2 tournevis Phillips, et Marteau
- Attention: Si vous utilisez une perceuse électrique ou un tournevis électrique pour visser, veillez à ralentir et arrêter lorsque la vis est bien serrée. Le non-respect de cette consigne peut endommager la vis.

Système de Fixation de Came (page 3)

Ce Système de Fixation de Came sera utilisé tout au long de l'assemblage

Identification des matériaux (Page 4-7)

Pas de taille réelle

- | | |
|-------------------------------|-------------------------------|
| (A) PANNEAU SUPÉRIEUR | (K) ÉTAGÈRE RÉGLABLE |
| (B) PANNEAU INFÉRIEUR | (L) ÉTAGÈRE FIXE |
| (C) PANNEAU AVANT | (M) PANNEAU INFÉRIEUR DU DOS |
| (D) PANNEAU LATERAL GAUCHE | (N) PANNEAU ARRIÈRE SUPÉRIEUR |
| (E) PANNEAU LATÉRAL DROIT | (O) JAMBE ARRIERE GAUCHE |
| (F) CLOISON SUPÉRIEURE GAUCHE | (P) JAMBE ARRIERE DROITE |
| (G) CLOISON SUPÉRIEURE DROITE | (Q) JAMBE AVANT GAUCHE |
| (H) CLOISON INFÉRIEURE GAUCHE | (R) JAMBE AVANT DROITE |
| (I) CLOISON INFÉRIEURE DROITE | (S) TUBE SUPPORT |
| (J) TABLETTE RÉGLABLE | (T) JAMBE |
| | (U) LUMIÈRE DEL |

Liste des pièces (Page 8)

Taille réelle

- (1) Cheville en bois
- (2) Vis
- (3) Vis
- (4) Boulon
- (5) Boulon
- (6) Boulon à came

Liste des pièces (Page 9)

Pas de taille réelle

- (7) Serrure à came
- (8) Couvercle de came
- (9) Support d'étagère
- (10) Attache métallique
- (11) Colle
- (12) Clé hexagonale
- (13) Étiquette d'avertissement

Page 10

- 1.1 Fixez (6) à (A) et (C) comme illustré.
- 1.2 Fixez (1) à (B) et (C) comme illustré.

Page 11

- 2.1 Fixez (6) à (D), (E) et (L) comme illustré.
- 2.2 Fixez (1) à (D), (E) et (L) comme illustré.

Page 12

- 3.1 Fixez (1) à (F), (G), (H), (I), (N) et (M) comme illustré.

Page 13

- 4.1 Fixez (U) à (A) avec (10) et (3) comme illustré.

Page 14

- 5.1 Fixez (H), (I) à (M) avec (2) comme illustré.

Page 15

- 6.1 Fixez (F), (G) à (L) avec (2) comme illustré.

Page 16

- 7.1 Fixez (H), (I), (M) à (L) avec (7) comme illustré.
- 7.2 Utilisez (8) pour couvrir les trous de verrouillage à came comme illustré.

Page 17

- 8.1 Fixez (B) à l'échantillon de l'étape précédente avec (2) comme illustré.

Page 18

9.1 Fixez (C) à (B), (H) et (I) avec (7) comme illustré.

9.2 Utilisez (8) pour couvrir les trous de verrouillage à came comme illustré.

Page 19

10.1 Fixez (D), (E) à l'échantillon de l'étape précédente avec (7) comme illustré.

10.2 Fixez (N) à (D) et (E) avec (7) comme illustré.

10.3 Utilisez (8) pour couvrir les trous de verrouillage à came comme illustré.

Page 20

11.1 Attachez (A) à l'échantillon de l'étape précédente avec (7) comme illustré.

11.2 Utilisez (8) pour couvrir les trous de verrouillage à came comme illustré.

Page 21

12.1 Fixez (O), (P), (Q) et (R) à (D) et (E) avec (4) comme illustré.

12.2 Fixez (S) à (O), (P), (Q) et (R) avec (5) comme illustré.

12.3 Fixez (T) à (B) comme illustré.

Page 22

13.1 Insérez (9) dans (D), (E), (F) et (G) comme illustré.

13.2 Insérez et placez (J), (K) sur (9) comme illustré.

Page 23

Appliquez l'étiquette d'avertissement au centre du panneau supérieur comme indiqué, assurez-vous que le téléviseur couvre l'étiquette en cours d'utilisation.

Vous ne pourrez pas retirer l'étiquette après l'avoir appliquée sur le panneau supérieur.

Avertissement : risque de mort ou de blessures graves. Cet appareil doit être placé contre un mur fixe au moins aussi haut qu'un téléviseur.

Page 24

CHARGES MAXIMALES

Ce meuble a été conçu pour supporter les charges maximales indiquées. En excédant ces limites de charge, le meuble pourrait devenir instable, s'effondrer, et/ou causer des blessures graves.

AVERTISSEMENT: Appliquez l'étiquette d'avertissement du téléviseur sur votre appareil afin d'avoir toujours les limites de poids et de taille du téléviseur du modèle.

Taille maximale du téléviseur : écran plat 65".

Page 25

Enregistrez votre produit pour recevoir les éléments suivantes:

- * Détails sur les nouvelles tendances - un aperçu sur les nouveautés
- * Sondages - avoir une voix au sein de notre communauté
- * Offres exclusives et codes promo
- * Service de pièces de rechange rapide et facile

Pour enregistrer votre produit, visitez ameriwoodhome.com - 5 Étoiles

Visitez le site Web de votre détaillant local, évaluez le produit que vous avez acheté et laissez-nous vos commentaires !

Nous tenons à offrir un grand "Merci" à tous nos clients pour avoir pris le temps d'assembler ce produit "Ameriwood Home", et de nous donner vos commentaires précieux.

Merci